

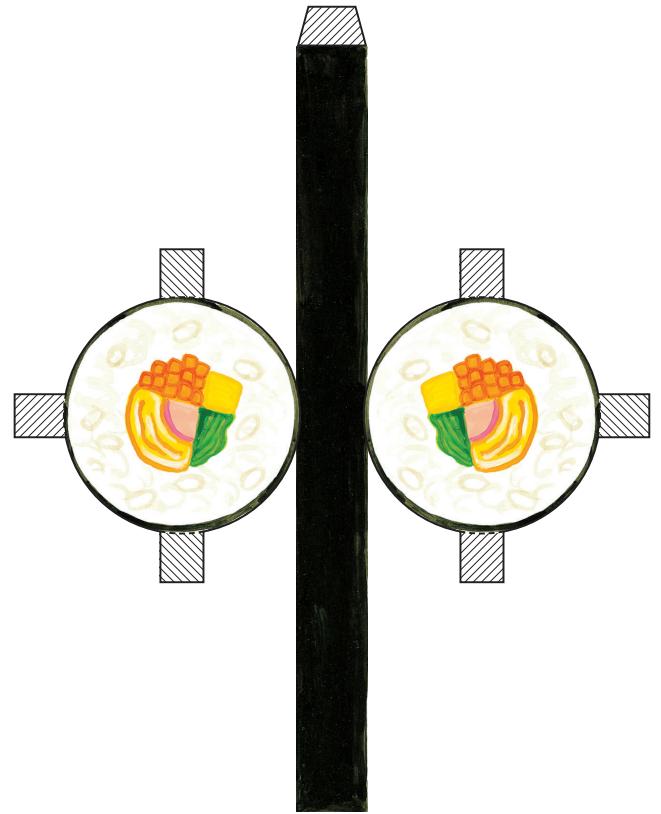

(책읽는곰) 나만의 도시락 만들기



- 오리기
- - - - - 접기
- //// //// 풀칠하기



나만의 도시락 만들기

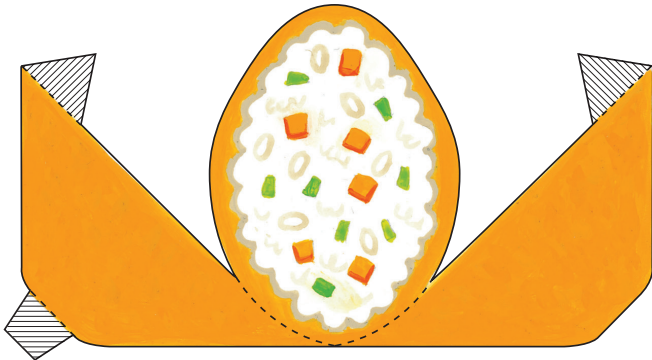
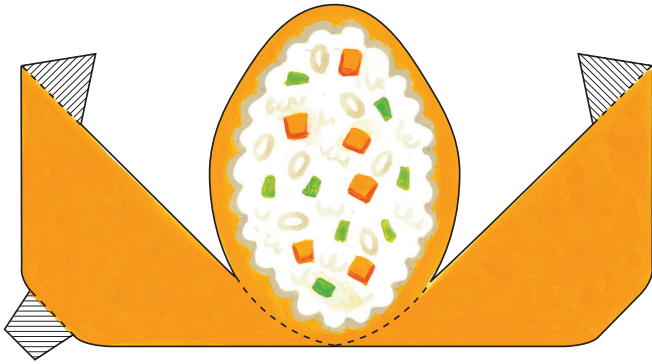

유부 초밥

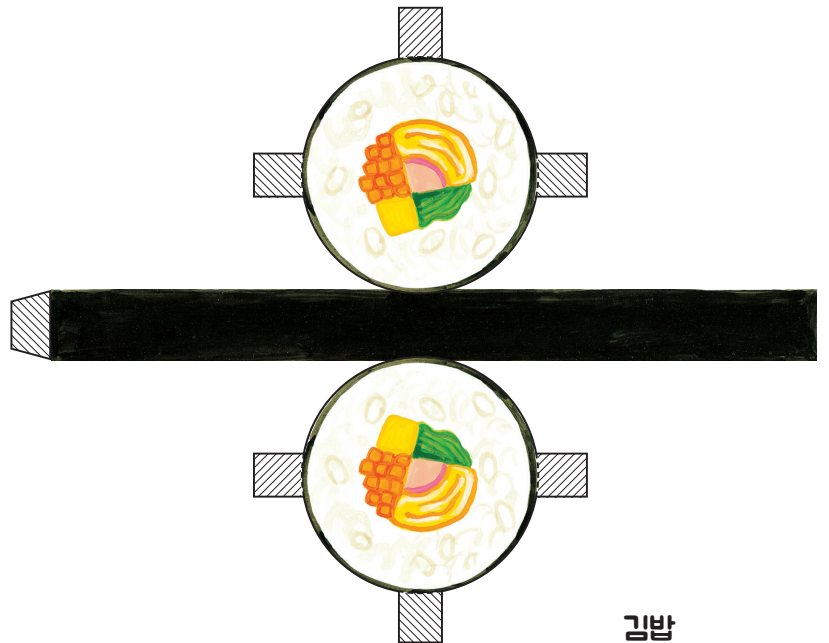

김밥

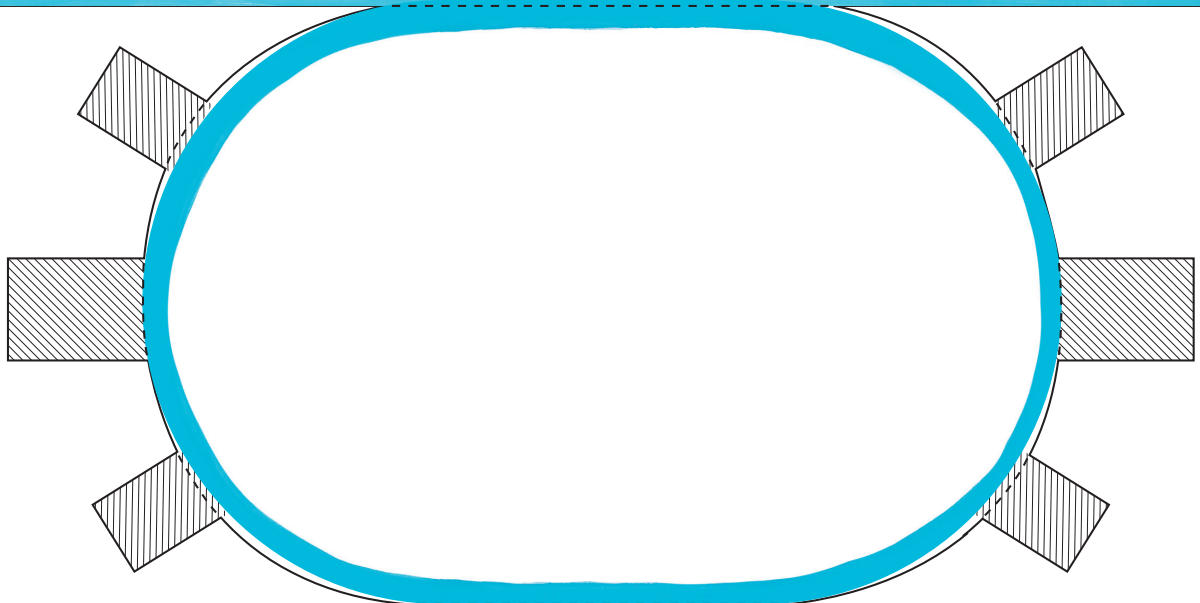

세상에 하나뿐인
나만의 도시락으로
멋지게 꾸며 보세요!



도시락 뚜껑

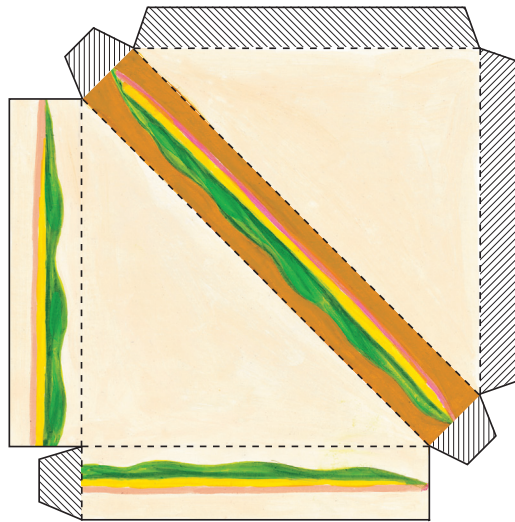
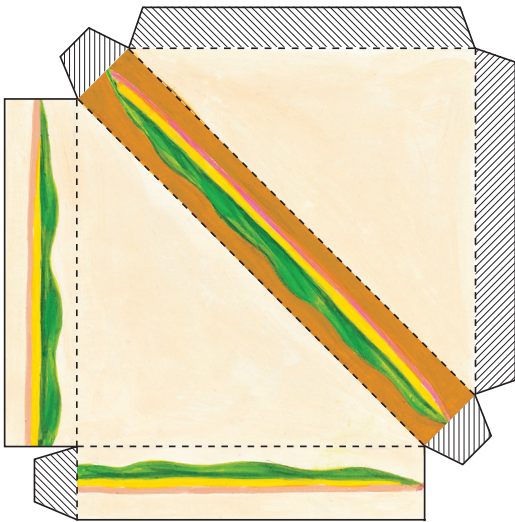

샌드위치

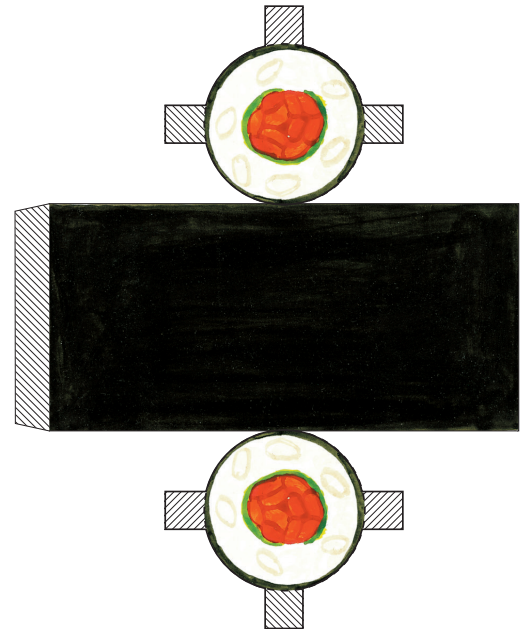

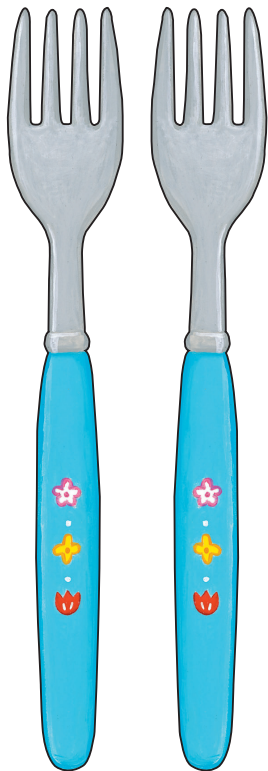

포크

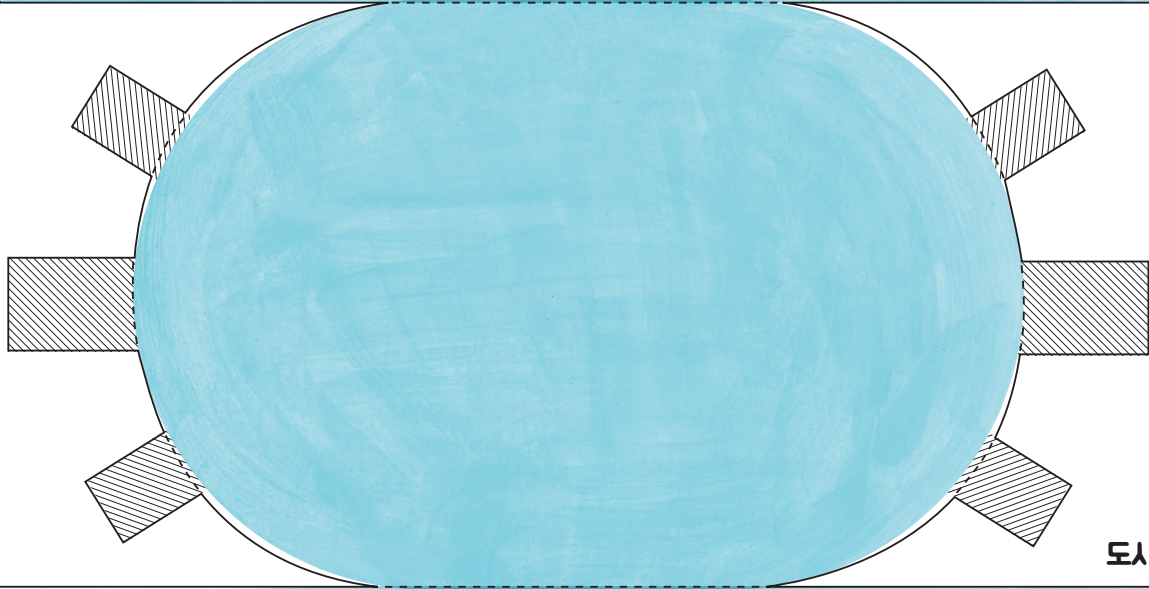

도시락 그릇

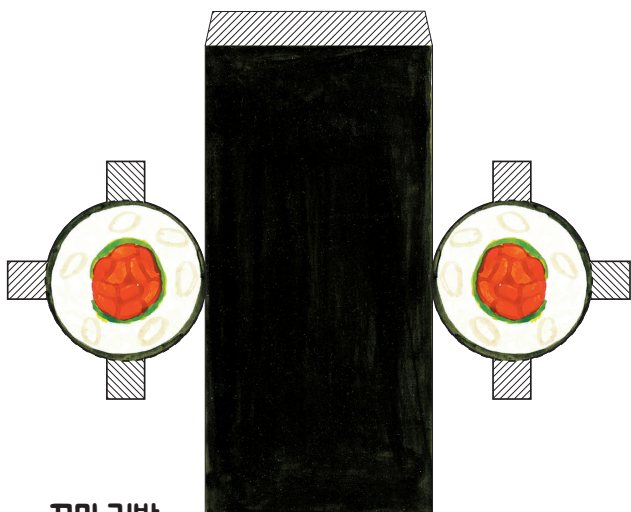

포마 김밥

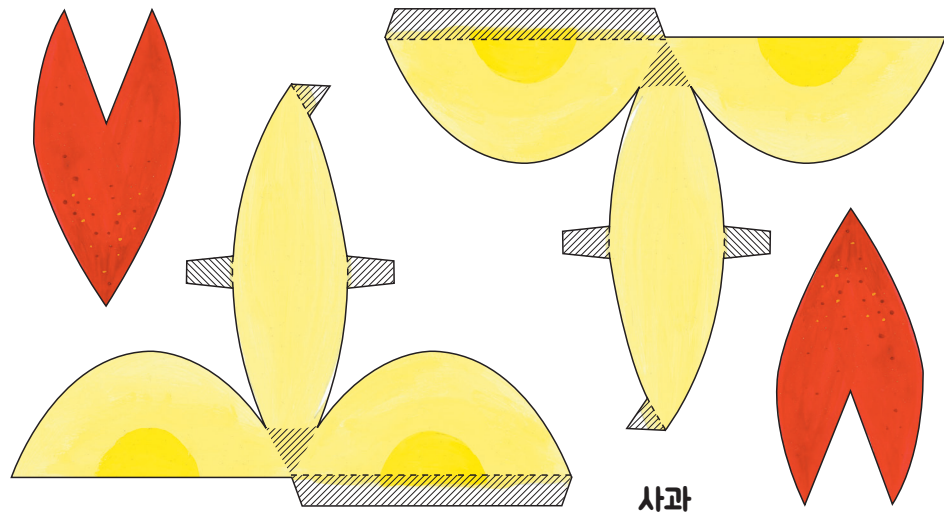

사과

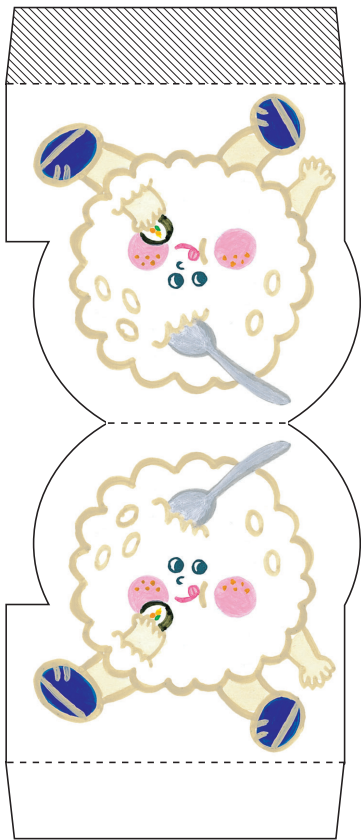

먹보 밥보

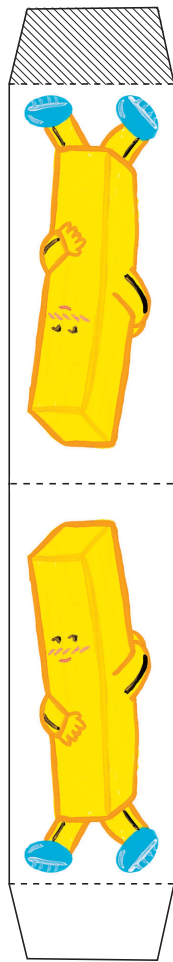

단무지 씨

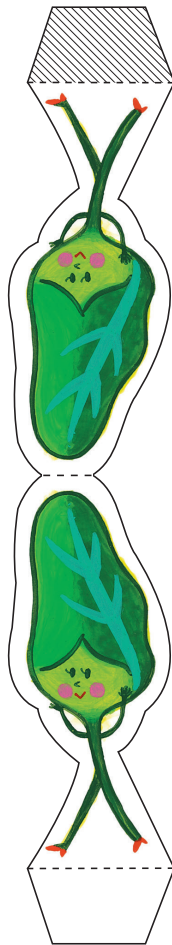

시금치 양

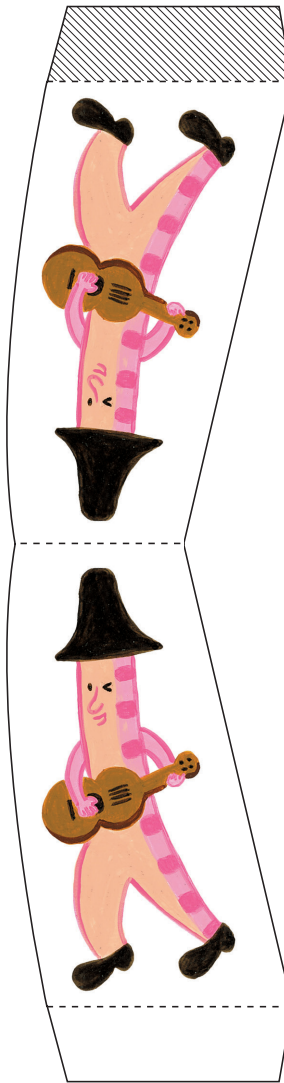

햄만

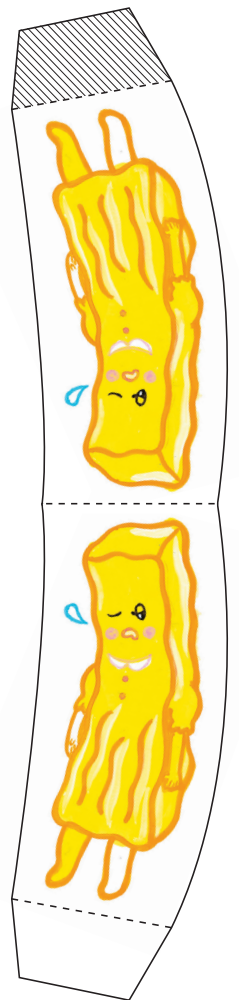

달걀지단

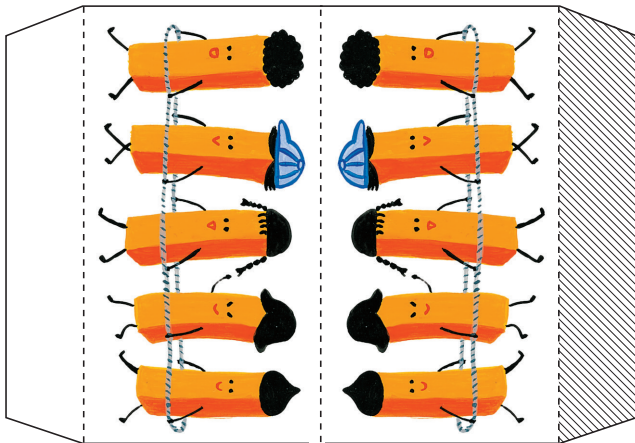

고아 당근 친구들

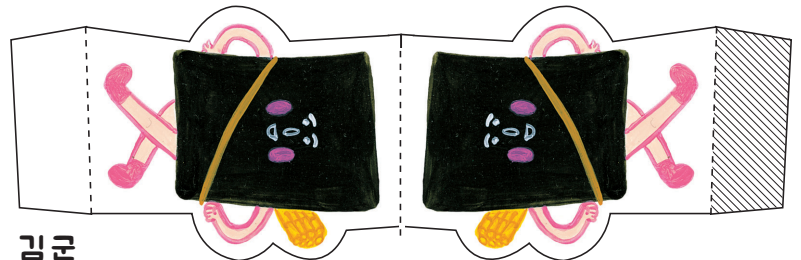

김군



주소 03973 서울시 마포구월드컵북로12길 74 102호

전화 02.332.2672

전자우편 bear@bearbooks.co.kr

SNS facebook.com/bearbookspage